

Step 1. Prepare connector components and strip coaxial cable according to given dimensions (check point 1)

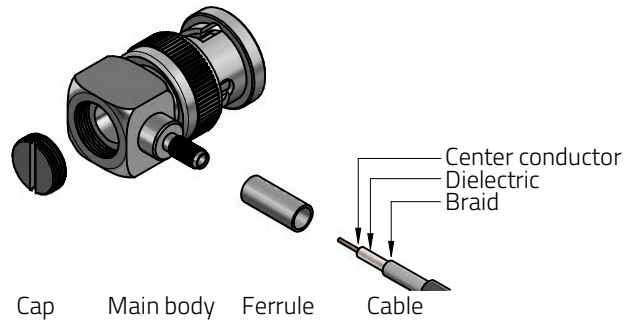

Step 2. Please slide ferrule onto cable and splay out cable braid

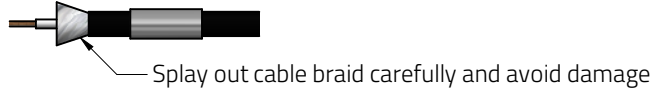

Step 3. Insert cable into connector main body until cable dielectric is attached to connector internal positioning point. Check and make sure cable center conductor sits inside solder slot. Solder cable center conductor using minimum amount of solder paste (check point 2)

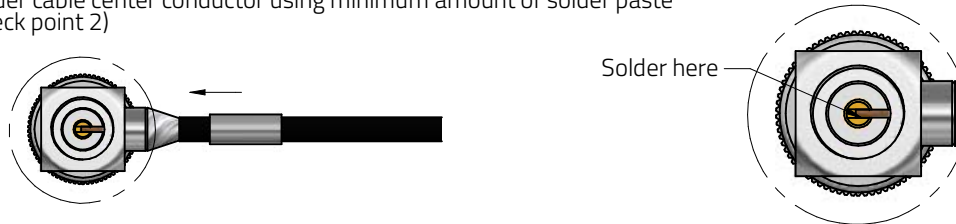

Step 4. Cover cable braid over connector neck and push ferrule toward main body. Screw the cap on to connector slowly (check point 3)

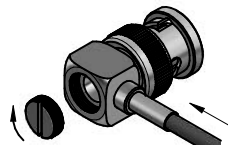

Step 5. Crimp ferrule with tool hex size : .128" (check point 4)



Assembly Method :

Center contact : Soldered
Outer contact : Crimp

Crimp Tool PN : 600600

Crimp Head PN : 60060060101



Cable Type : Flexible Cable RG174/RG188/RG316

Cable Strip Dimensions (mm) :

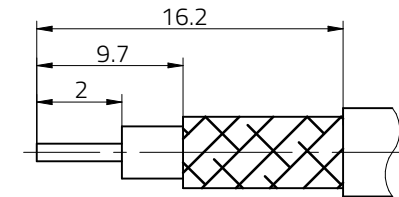

Check Point :

1. No damaged components; and no split cable after stripping
2. No excess or lack solder flow, no evidence of melting

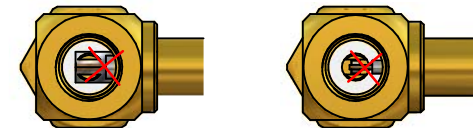

3. Remove or cut exposed cable braid with scissor or utility knife

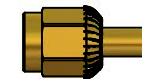

4. No significant dog ear after crimping



CREATED CTc	CHECKED JCh		
DESCRIPTION Assembly instructions 607 360 222 103 20			
REVISION 001.001	STATUS Valid	DATE 2023-06-12	BUSINESS UNIT eiCan



Würth Elektronik eiSos GmbH & Co. KG
EMC & Inductive Solutions
Max-Eyth-Str. 1
74638 Waldenburg
Germany
Tel. +49 (0) 79 42 945 - 0
www.we-online.com
eiSos@we-online.com